

# ASSEMBLY GUIDE

## KONA BED

Option A

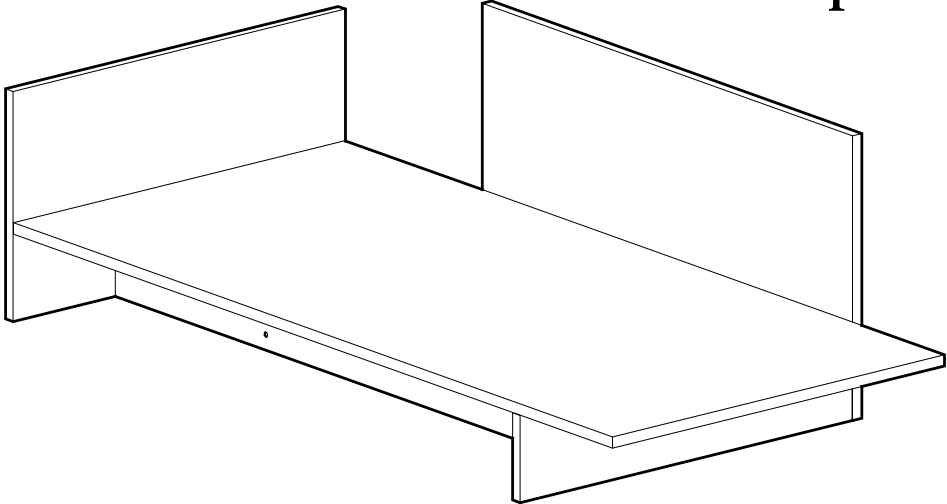



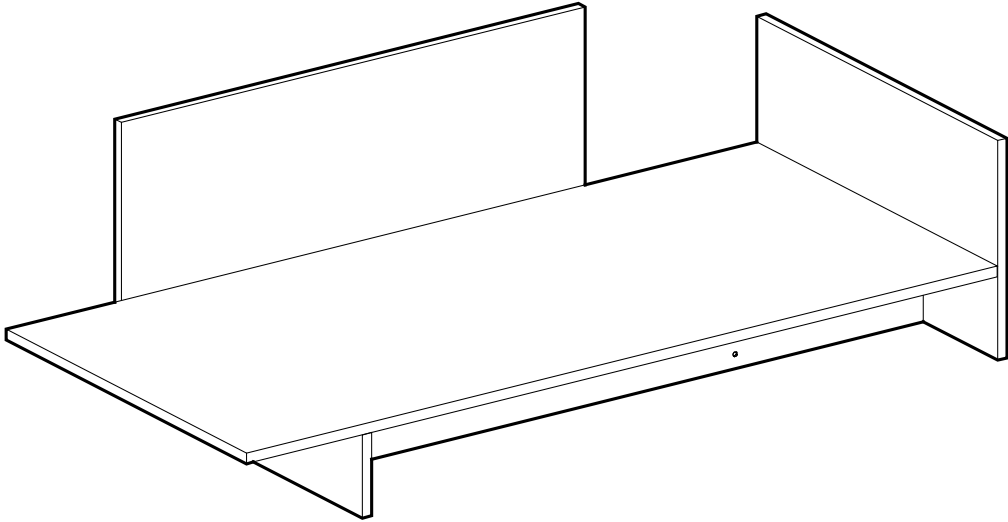



Option B

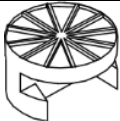

IMPORTANT, RETAIN FOR FUTURE REFERENCE: READ CAREFULLY  
MUST BE ASSEMBLED BY AN ADULT!

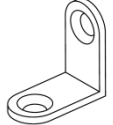
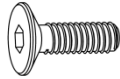

# PARTS LIST

A		x20	B		x10	C		x10
	8x30			15x35			58x8.5	
D		x18	E		x36	F		x1
	25x13			M6x16/12			4mm	
G		x8	H		x14	I		x1
	D=14			D=18			6mm	

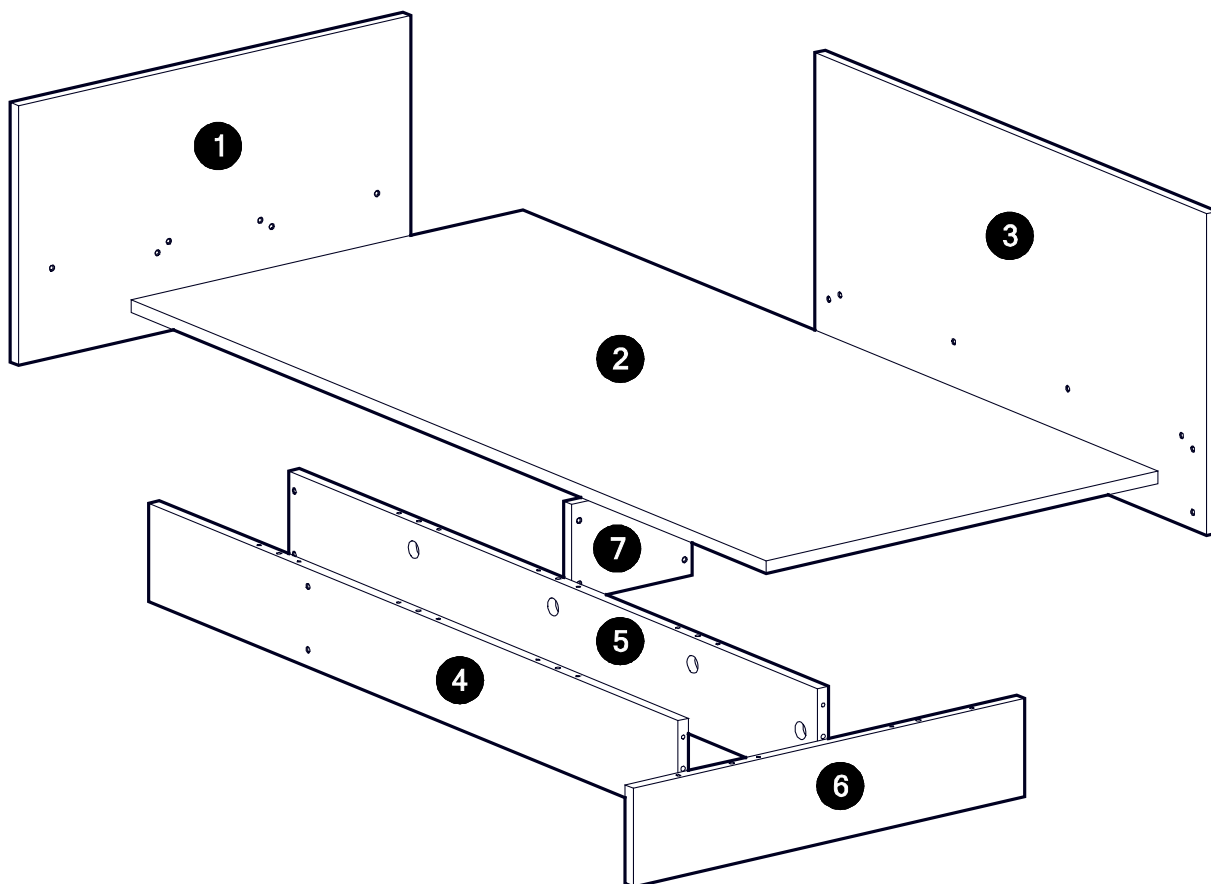

Item number	Dimensions	Pcs
1.	942 x 525 x 26	1
2.	2040 x 940 x 26	1
3.	1260 x 650 x 26	1
4.	1700 x 199 x 26	1
5.	1700 x 199 x 26	1
6.	940 x 199 x 26	1
7.	289 x 199 x 26	1

## TOOLS NEEDED FOR ASSEMBLY

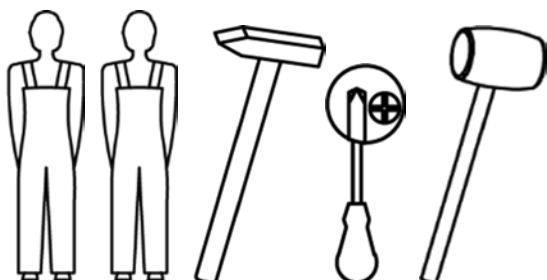

1.

C		x8
58x8.5		

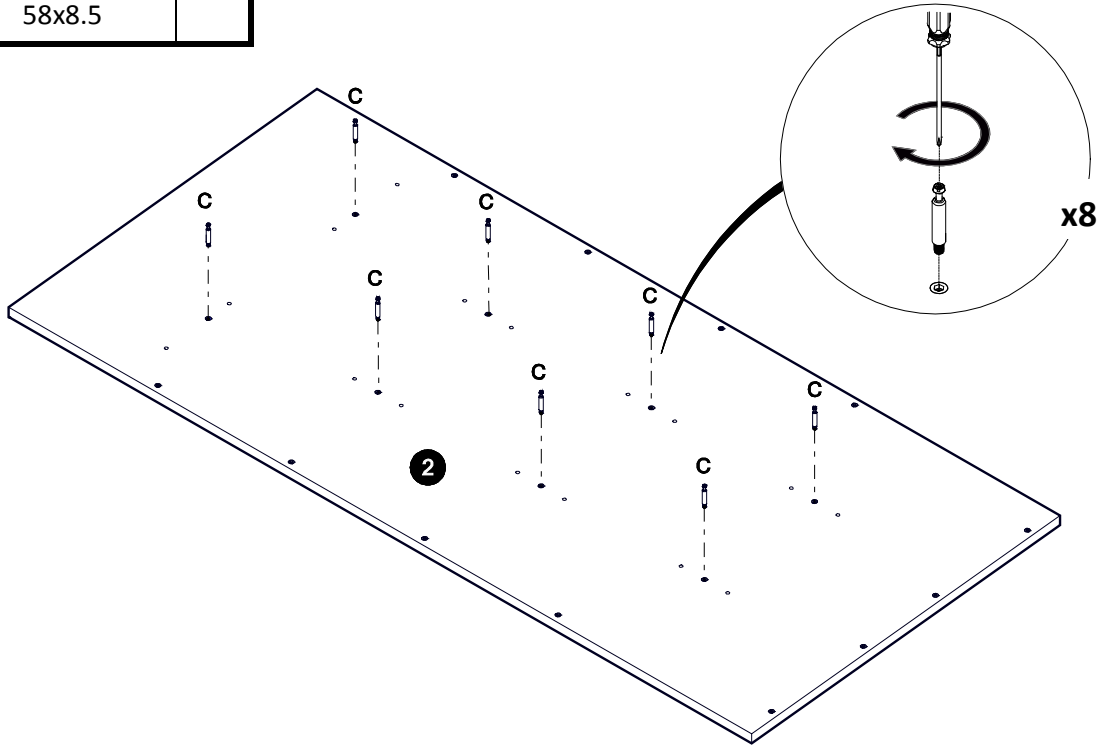

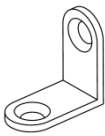
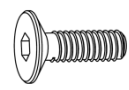
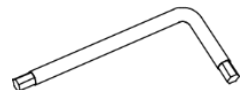

2.

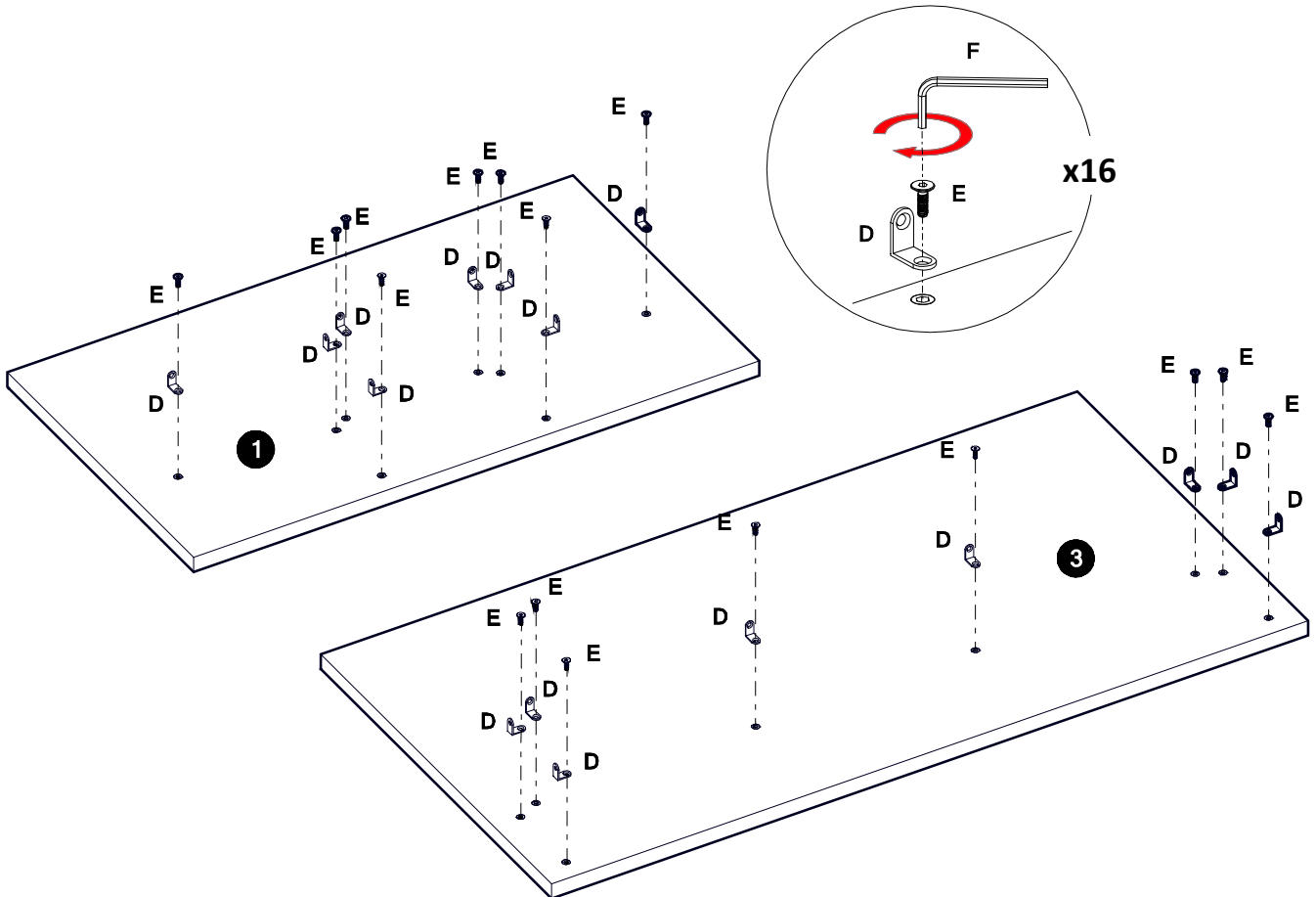
D		x16	E		x16	F		x1
25x13			M6x16/12			4mm		



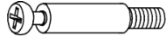
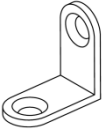
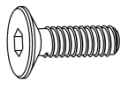

3.

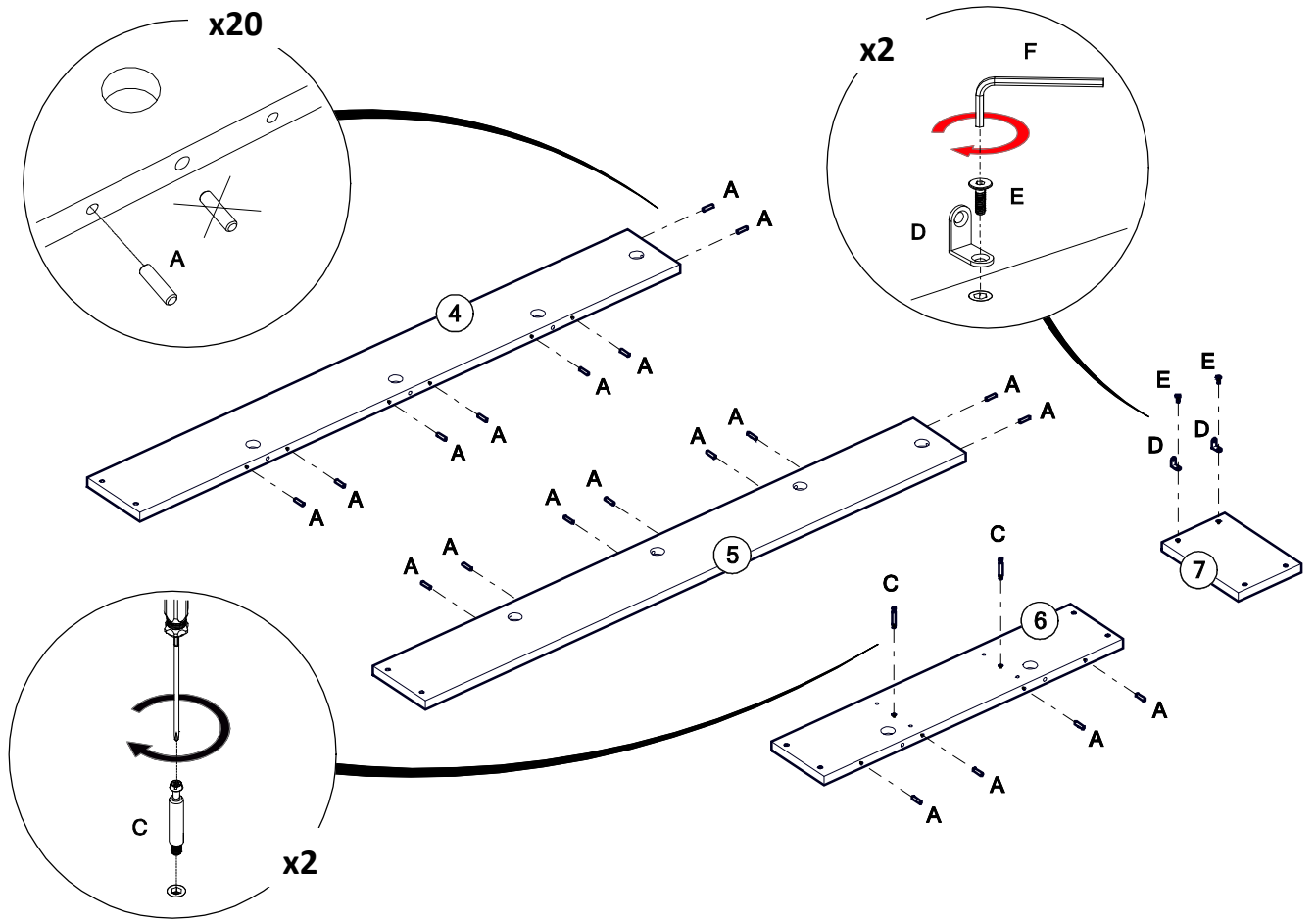
A		x20	C		x2	D		x2	E		x2
	8x30			58x8.5			25x13			M6x16/12	
									F		x1



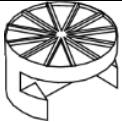

4.

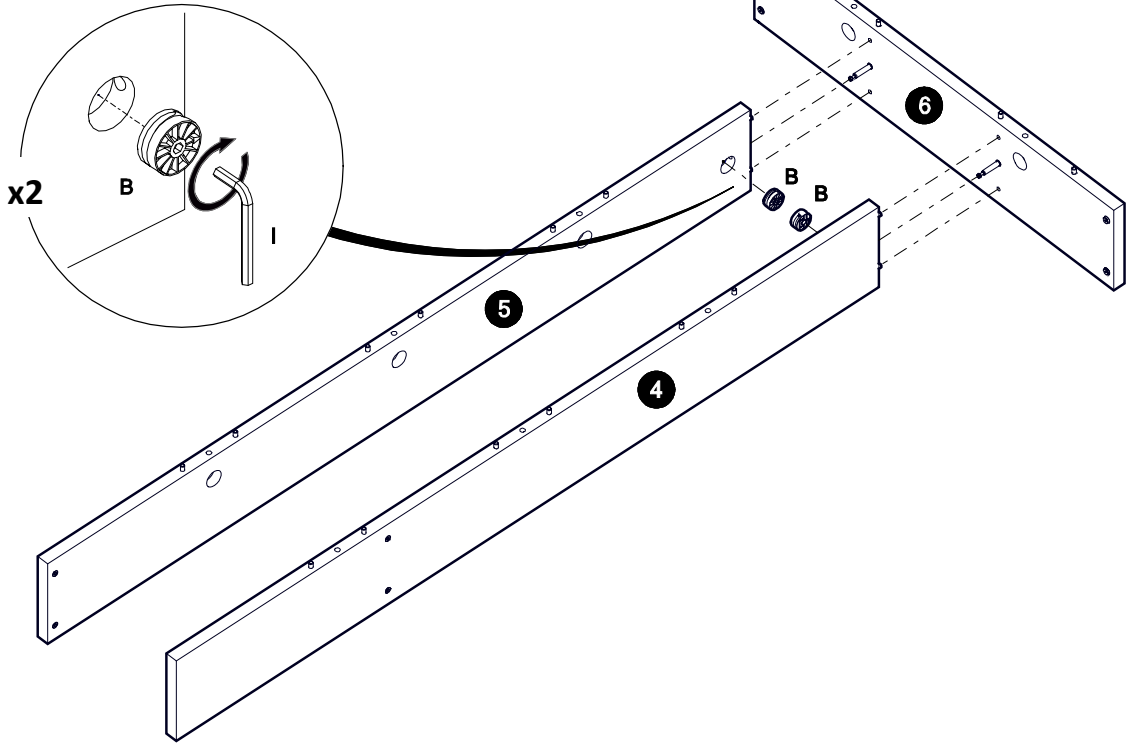
B		x2	I		x1
	D=35			6mm	

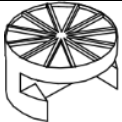

5.

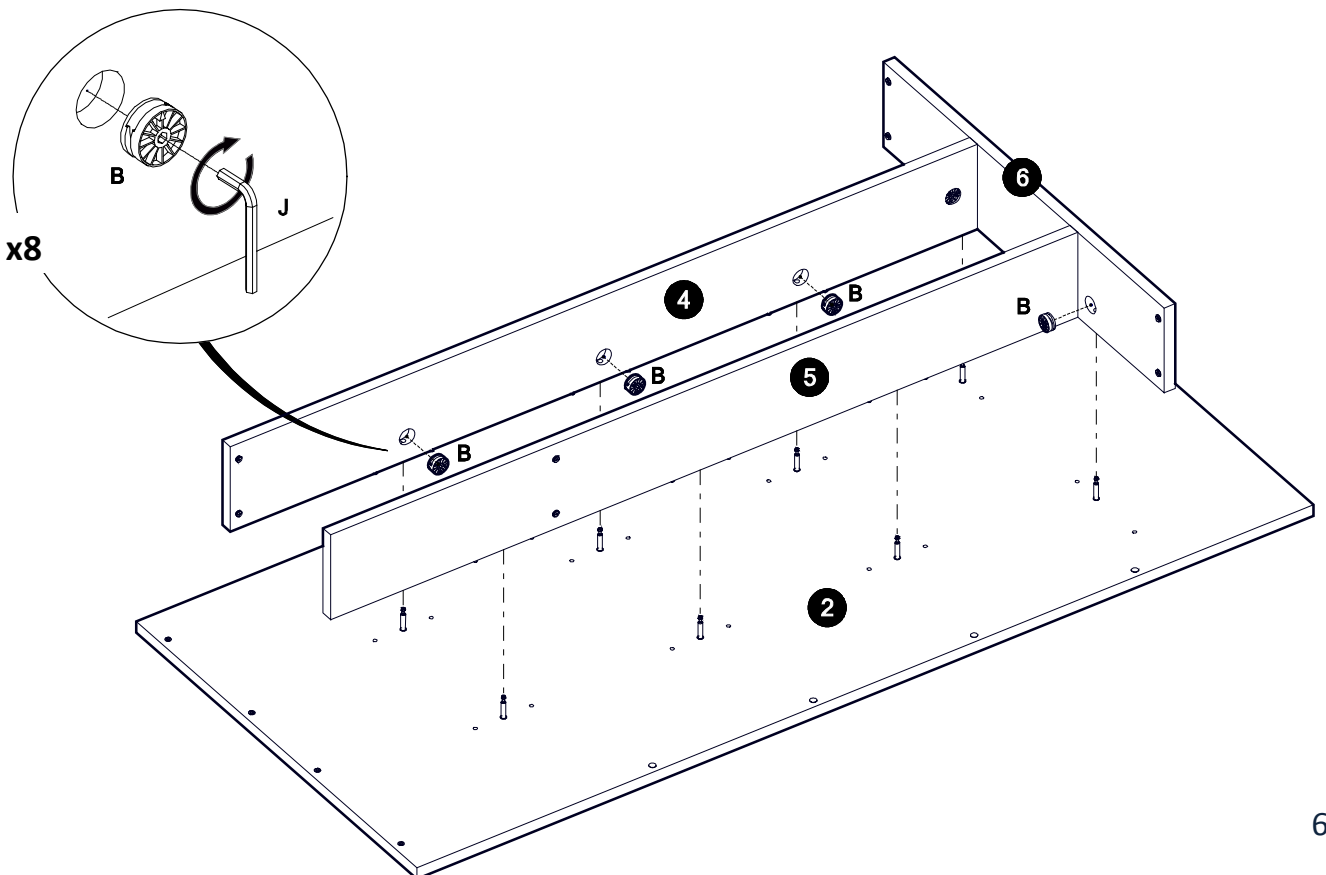

B		x8	I		x1
	D=35			6mm	

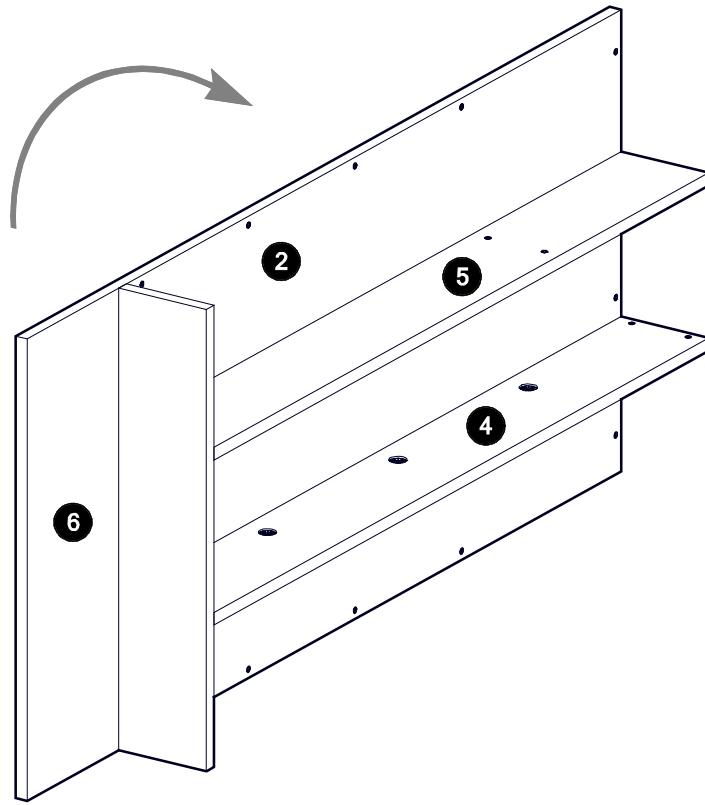

6.



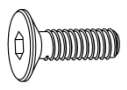

7.

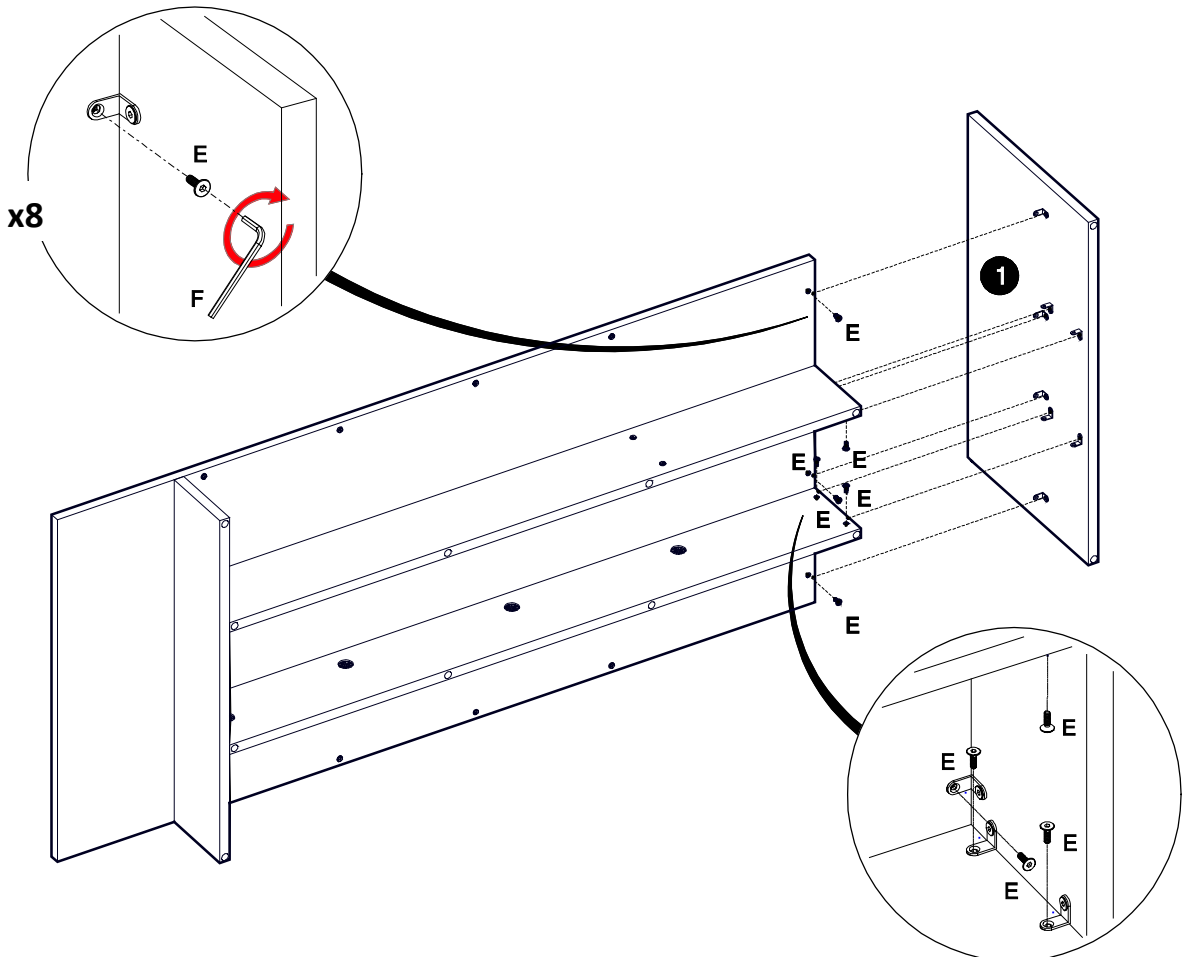
E		x8	F		x1
	M6x16/12			4mm	



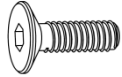

8.

E		x2	F		x1
	M6x16/12			4mm	

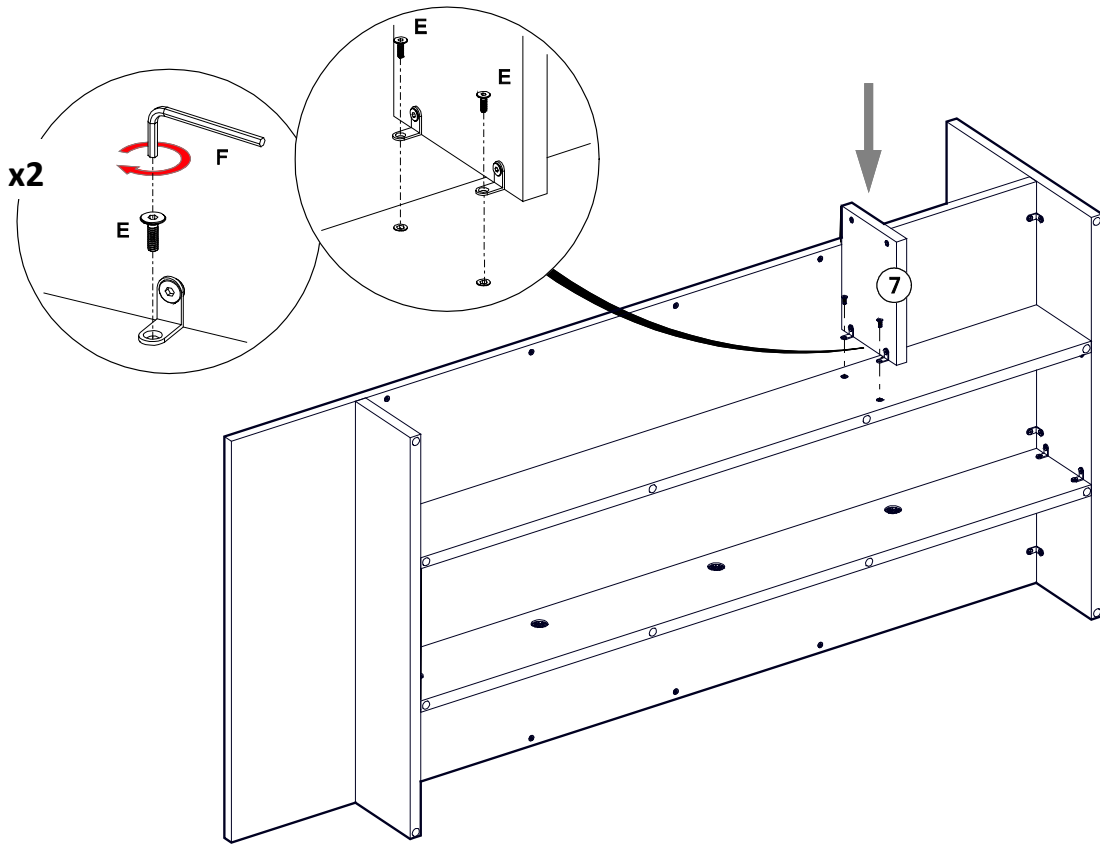
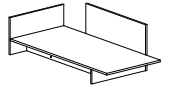
Option A

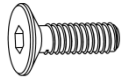

9.

E		x8	F		x1
	M6x16/12			4mm	

Option A

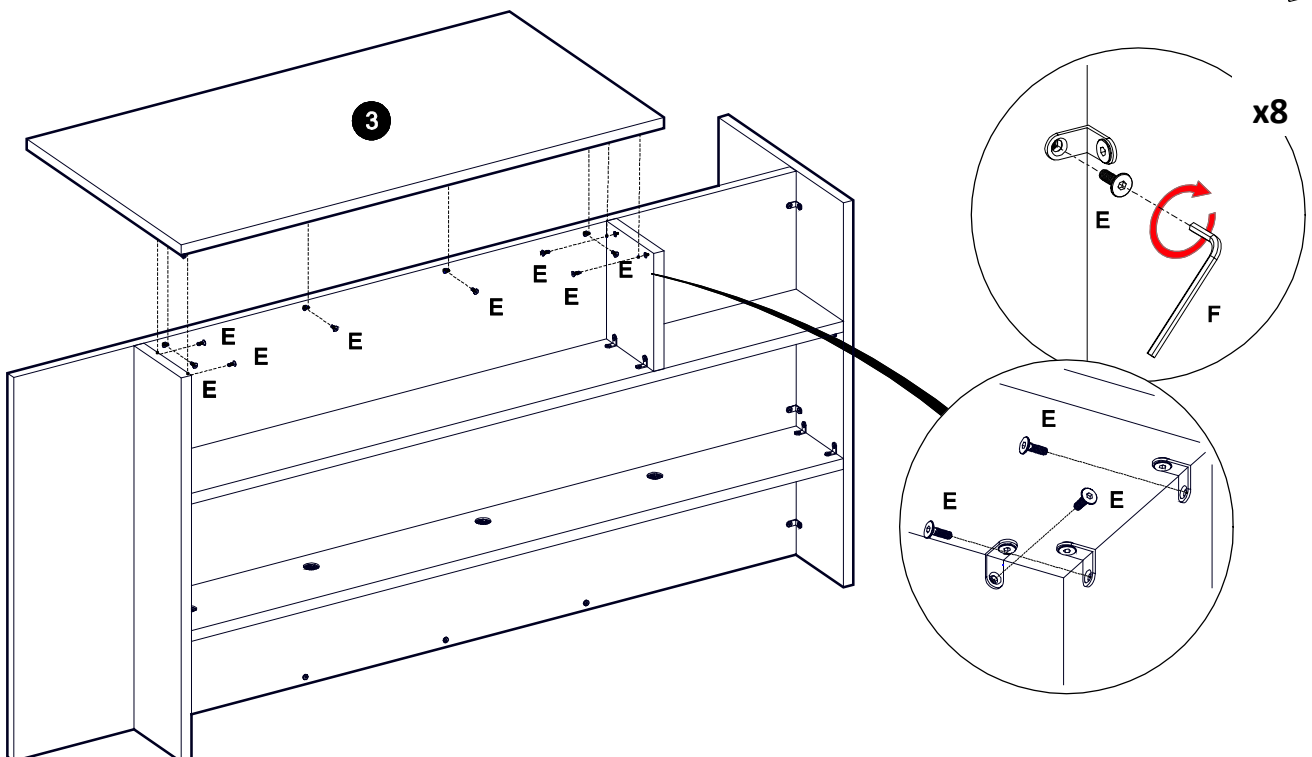
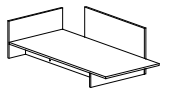



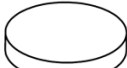

10.

G		x8	H		x14
	D=14			D=18	

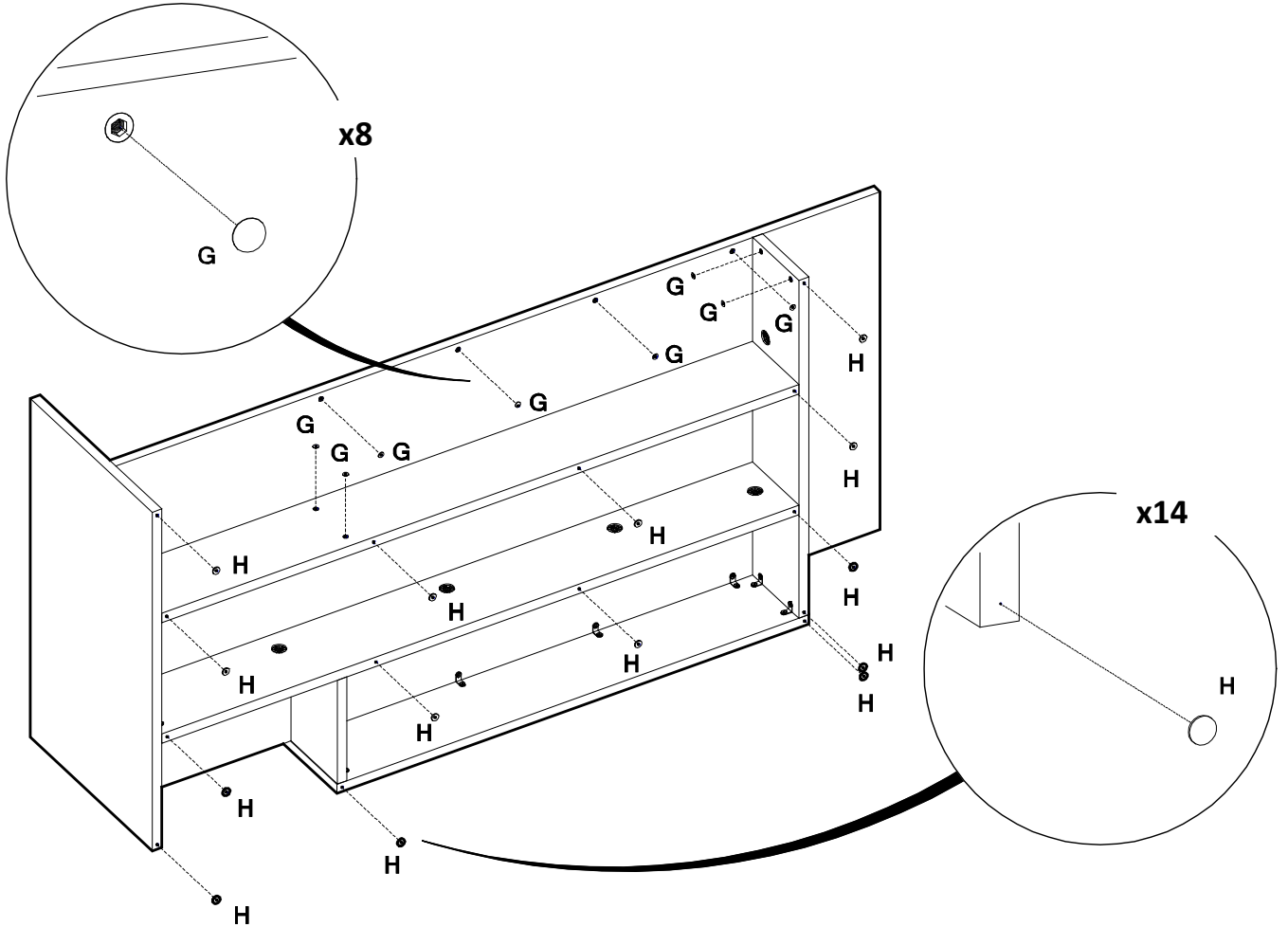
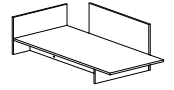
Option A



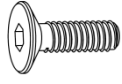

8.

E		x2	F		x1
	M6x16/12			4mm	

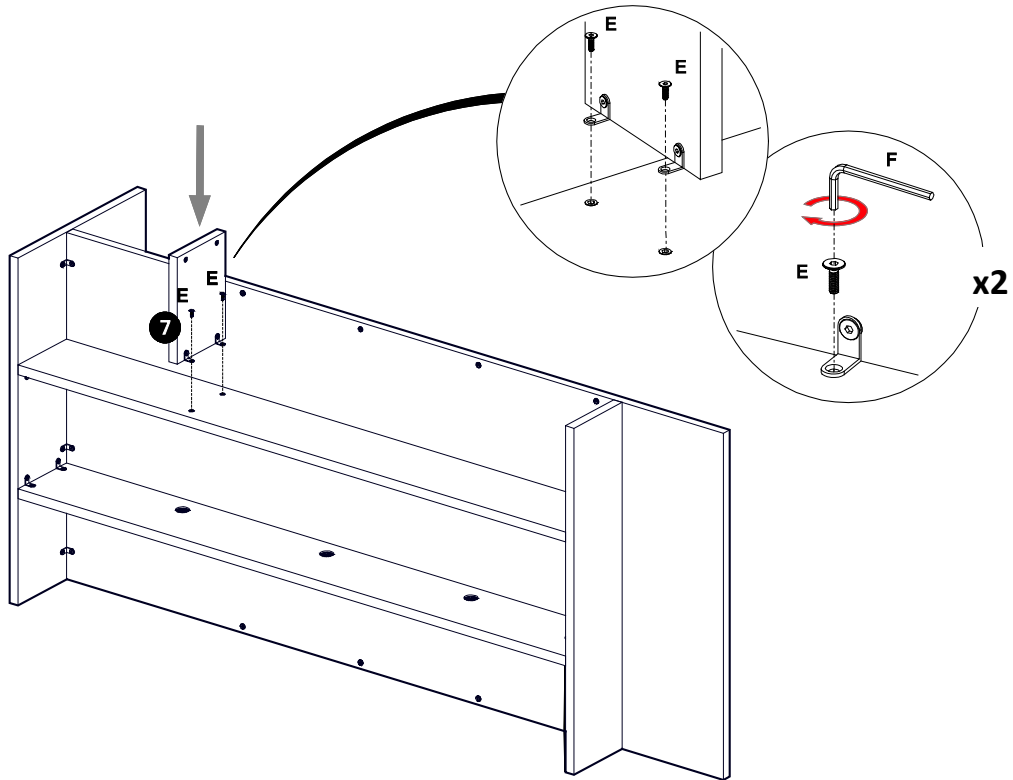
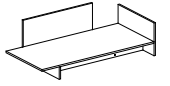
Option B



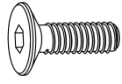

9.

E		x8	F		x1
	M6x16/12			4mm	

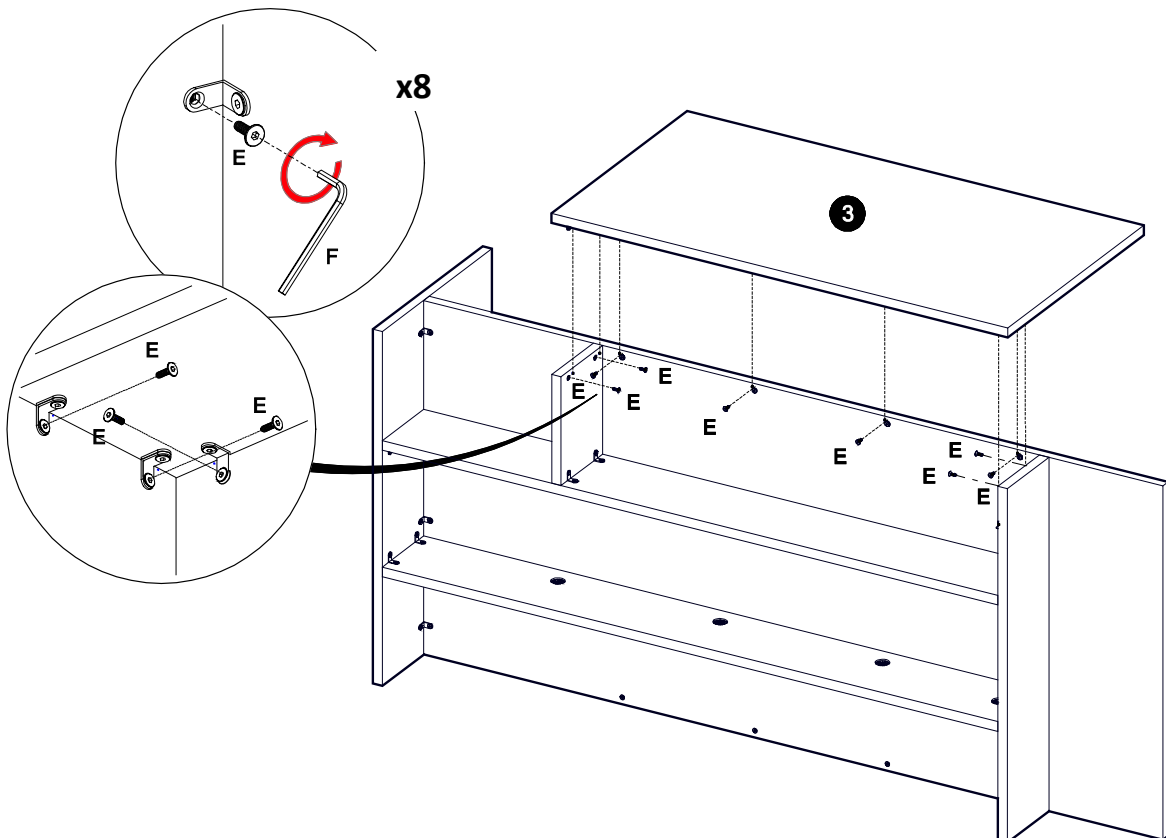
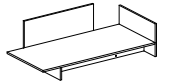
Option B



10.

G	 D=14	x8	H	 D=18	x14
---	---	----	---	---	-----

Option B

